

# OPERATING MANUAL

2022

Crop Chaser 1000



2800 7<sup>th</sup> Avenue North  
Fargo, ND 58108

Phone: (701) 232-4199  
Fax: (701) 234-1716  
[www.amitytech.com](http://www.amitytech.com)

This page is intentionally left blank.

## AMITY TECHNOLOGY LLC LIMITED WARRANTY TERMS AND CONDITIONS – UNITED STATES

### EFFECTIVE FOR EQUIPMENT RETAILED AND DELIVERED AFTER JUNE 1, 2020

**WHAT IS WARRANTED** Amity Technology warrants its new equipment to be free of defects in material and workmanship at time of delivery to the first retail purchaser, renter, or lessee. Amity Technology warrants any new or unused part which is manufactured by Amity Technology for use in an Amity Technology machine, jointly referred to as “Products”, whether such Product is purchased through an authorized Amity Technology dealer or directly from Amity Technology. Under this Warranty, Amity Technology will repair or replace, as it chooses in its sole discretion, any covered Product, or any component thereof, which Amity determines to be defective. These terms apply to all Amity Technology brands of new equipment originally marketed in the United States.

#### WARRANTY PERIOD

- 12 Months from the date of delivery to the first retail purchaser, renter or lessee.

#### EXCEPTIONS FROM THIS WARRANTY

- **Freight Charges** - This warranty does not cover freight charges.
- **Improvements, Changes, or Discontinuance** Amity Technology reserves the right to make changes and improvements in design or changes in specifications at any time to any product without incurring any obligations to owners of products previously sold.
- **Repairs and Maintenance Not Covered Under Warranty** - This warranty does not cover conditions resulting from misuse, natural calamities, use of non-Amity Technology parts, negligence, alteration, accident, use of unapproved attachments, usage which is contrary to the intended purposes, or conditions caused by failure to perform required maintenance. Replacement of Wear or Maintenance items (unless defective) such as but not limited to, filters, hoses, belts, lubricants, light bulbs, wheel alignment, tightening of nuts, belts, bolts, and fittings, service tune-up, computer parameter adjustments and general adjustments which may from time to time be required are not covered.
- **Rubber Tire Warranty** - Rubber tires are warranted directly by the respective manufacturer only and not by Amity Technology.

#### OWNER'S OBLIGATION

It is the responsibility of the Owner to transport the equipment or parts to the service shop of an authorized Amity Technology Dealer or alternatively to reimburse the Dealer for any travel or transportation expense involved in fulfilling this warranty. This Warranty does NOT cover rental of replacement equipment during the repair period, damage to products which have been declared a total loss and subsequently salvaged, overtime labor charges, freight charges for replacement parts, or special handling requirements (such as, but not limited to, the use of cranes).

#### EXCLUSIVE EFFECT OF WARRANTY AND LIMITATION OF LIABILITY

THIS WARRANTY IS IN LIEU OF ALL WARRANTIES OF MERCHANTABILITY, FITNESS FOR A PURPOSE OR OTHER REPRESENTATIONS, WARRANTIES OR CONDITIONS, EXPRESSED OR IMPLIED. The remedies of the Owner set forth herein are exclusive. The Company neither assumes nor authorizes any person to assume for it any other obligation or liability in connection with the sale of covered machines. Correction of defects, in the manner and for applicable period of time provided above, shall constitute fulfillment of all responsibilities of Amity Technology to the Owner, and Amity Technology shall not be liable for negligence under contract or in any manner with respect to such machines. IN NO EVENT SHALL THE OWNER BE ENTITLED TO RECOVER FOR INCIDENTAL, SPECIAL OR CONSEQUENTIAL DAMAGES SUCH AS BUT NOT LIMITED TO, LOSS OF CROPS, LOSS OF PROFITS OR REVENUE, OTHER COMMERCIAL LOSSES, INCONVENIENCE OR COST OF RENTAL OR REPLACEMENT EQUIPMENT.

Some States or Provinces do not permit limitations or exclusions of implied warranties or incidental or consequential damages, so the limitations or exclusions in this warranty may not apply.

#### Additional Warranty Information

**New Equipment Warranty** - Equipment is eligible for warranty service only if it qualifies under the provisions of the New Equipment Warranty. The selling dealer will deliver this Warranty to the original retail purchaser at the time of sale, and the dealer will register the sale and Warranty with Amity Technology LLC.

**Subsequent Owners** - This Warranty covers the first retail purchaser and all subsequent owners of the equipment during the specified warranty period. Should the Amity Technology Dealer sell this equipment to a subsequent owner, the Dealer must deliver the warranty document to the subsequent owner so the subsequent owner can register ownership with Amity Technology and obtain the remaining warranty benefits, if available, with no intermission in the Warranty Period. Subsequent Owner Procedure will apply. It is the responsibility of the subsequent owner to transport the equipment to the service shop of an authorized Amity Technology Dealer or alternatively to reimburse the Dealer for any travel or transportation expense involved in fulfilling this warranty. This Warranty does NOT cover charges for rental or replacement equipment during the repair period, products which have been declared a total loss and subsequently salvaged, overtime labor charges, freight charges for replacement parts, or units sold at auction.

**Warranty Service** - To be covered by Warranty, service must be performed by an authorized Amity Technology Dealer. It is recommended that you obtain warranty service from the Dealer who sold you the equipment because of that Dealer's continued interest in you as a valued customer. In the event this is not possible, warranty service may be performed by any other authorized Amity Technology Dealers in the United States or Canada. It is the responsibility of the Owner to transport the equipment to the service shop of an authorized Amity Technology Dealer or alternatively to reimburse the Dealer for any travel or transportation expense involved in fulfilling this warranty.

**Maintenance Service** - The Owner's Manual furnished to you with the equipment at the time of delivery contains important maintenance and service information. You must read the manual carefully and follow all the maintenance and service recommendations. Doing so will result in greater satisfaction with your equipment and help avoid service and warranty problems. Please remember that failures due to improper maintenance of your equipment are not covered by warranty.

**Maintenance Inspections** - To insure the continued best performance from your agricultural equipment, we recommend that you arrange to make your equipment available to your selling Dealer for a maintenance inspection 30 days prior to warranty expiration.

This page is intentionally left blank.

## TABLE OF CONTENTS

---

<b>WARRANTY</b> .....	ii
<b>TABLE OF CONTENTS</b> .....	iv-v
<b>1.0 INTRODUCTION</b> .....	1-1
1.1 General Information.....	1-1
1.2 Serial Number.....	1-1
<b>2.0 SAFETY</b> .....	2-1
2.1 Recognizing Safety Information in Manual.....	2-1
2.2 General Harvester Safety.....	2-1
2.3 Maintenance and Operating Safety.....	2-2
2.4 Hydraulic Safety.....	2-3
2.5 Transport Safety.....	2-3
2.6 Safety Decals.....	2-4
<b>3.0 SPECIFICATIONS</b> .....	3-1
3.1 Cart Specifications.....	3-1
3.2 Track Specifications.....	3-1
3.3 Tractor Specifications.....	3-2
<b>4.0 PREPARATION</b> .....	4-1
4.1 Tractor Safety Preparation.....	4-1
4.2 Installing Hitch.....	4-1
4.3 Installing Front and Rear Weights.....	4-2
4.4 Check Unloading Chains.....	4-3
4.5 Check Drive Motor Chains.....	4-3
4.6 Tilt Cylinder Pin Location.....	4-3
<b>5.0 ATTACHING AND DETACHING</b> .....	5-1
5.1 Attaching Hydraulic and Electrical Systems.....	5-1
5.2 Attaching Cart to Tractor Drawbar.....	5-2
5.3 Testing for Proper Operation.....	5-4
<b>6.0 OPERATING THE CART</b> .....	6-1
6.1 Start Up.....	6-1
6.2 Filling the Cart.....	6-1
6.3 Unloading The Cart.....	6-2
6.4 Scale System.....	6-1
<b>7.0 TRANSPORTATION</b> .....	7-1
7.1 Warning Lights.....	7-1
7.2 Preparing for Transport.....	7-1
<b>8.0 MAINTENANCE</b> .....	8-1
8.1 Cleaning.....	8-1
8.2 Lubrication.....	8-3
8.3 Lubrication Locations.....	8-4
8.4 Track Undercarriage Lubrication.....	8-12
8.5 Chain Tensioning.....	8-13
<b>9.0 STORAGE</b> .....	9-1
9.1 End of the Season.....	9-1
9.2 Beginning of the Season.....	9-1

# **1.0 INTRODUCTION**

## **1.1 General Information**

Read this manual carefully to learn how to operate and service your machine correctly. Failure to read this manual can result in personal injury or equipment damage.

This manual is a permanent part of your machine and should remain with the machine when you sell it.

Measurements in this manual are given in both customary U.S. units and metric equivalents. Use only correct replacement parts and fasteners. Metric and inch fasteners require appropriate tools to install.

**NOTE:** Right- and left-hand sides are determined by facing in the direction the implement will travel when moving forward.

## **1.2 Serial Number**

Record the serial number, model number, and model year to help trace the machine in the event that it is stolen. Your dealer also needs these numbers for all warranty claims and for when you order parts.

The serial number is found on the serial number plate, which is located on the front of the machine as shown in Figure 1-1.

Record your serial number, model number, and model year in the space provided below.

**Serial Number:**

---

**Model Number:**

---

**Model Year:**

---



**Figure 1-1: Serial Number Plate Location**

## **2.0 SAFETY**

### **2.1 Recognizing Safety Information in Manual**

Figure 2-1 is the safety-alert symbol. When you see this symbol on your machine or in this manual, be alert to the potential for personal injury.

Follow recommended precautions and safe operating practices.



Figure 2-1: Safety-Alert Symbol

### **2.2 General Safety**

You are responsible for the safe operation and maintenance of your Amity implement. You and anyone else who will operate, maintain, or work around the machine should be familiar with the operating and maintenance procedures and safety information in this manual.

Safety practices protect you and the people around you, so make them a working part of your safety program.

Equipment owners must give operating instructions annually to operators or employees before allowing them to operate the machine, per OSHA regulation 1928.57.

The most important element of safety for this equipment is a safe operator. It is the operator's responsibility to read and follow all safety and operating instructions in the manual. All accidents can be avoided.

A person who has not read and understood all operating and safety instructions is not qualified to operate the machine. An untrained operator exposes himself and bystanders to serious injury or death.

Do not modify the equipment in any way. Unauthorized modification may impair the function or safety, or both, and could alter the life and warranty of the product.

The following list is a set of safety guidelines to adhere to:

1. Read and understand the Operator's Manual and all safety signs before operating, maintaining, or adjusting the machine.
2. Install and properly secure all shields and guards before operating.
3. Have a first-aid kit available and know how to use it.
4. Have a fire extinguisher available and know how to use it.
5. Clear the area of people and remove foreign objects from the machine before starting and operating.
6. Shift to park, disengage PTO, lower machine to ground, relieve hydraulic pressure, stop engine, remove ignition key, and wait for all moving parts to stop before servicing, adjusting, repairing, or disconnecting.

7. Annually review safety guidelines with all operators.
8. Wear suitable ear protection for prolonged exposure to excessive noise.

Think **SAFETY!** Work **SAFELY!**

### **2.3 Maintenance and Operating Safety**

1. Read and understand all information contained in the Operator's Manual regarding maintenance, adjustment, and operation of the machine.
-  2. Shift to park, disengage PTO, lower machine to ground, relieve hydraulic pressure, stop engine, remove ignition key, and wait for all moving parts to stop before servicing, adjusting, repairing, or disconnecting the machine.
3. Keep hands, feet, clothing, and hair away from all moving and/or rotating parts.
4. Ensure that all tractor controls are in neutral before starting.
5. Never wear ill-fitting, baggy, or frayed clothing when working on or around the machine.
6. Make sure that all guards and shields are properly installed and secured before operating the machine.
7. Clear the area of all bystanders, especially children, when carrying out any maintenance or making adjustments on the systems or components.
8. Place stands or blocks under the frame before working beneath the machine.
9. Do not allow riders on the implement or tractor during field operation or transport.
10. Never operate the machine inside a closed building.
11. Stay away from overhead obstructions and power lines during setup and operation. Electrocution can occur without direct contact.



## **2.4 Hydraulic Safety**

1. Always place all tractor hydraulic controls in neutral before dismounting.
2. Make sure that all components in the hydraulic system are kept in good condition and are clean and tight.
3. Replace any worn, cut, abraded, flattened or crimped hoses and metal lines.
4. Do not attempt any makeshift repairs to the hydraulic lines, fittings, or hoses by using tape, clamps, or cements. The hydraulic system operates under extremely high pressure. Such repairs may fail suddenly, creating a hazardous and unsafe condition.
5. Wear proper hand and eye protection when searching for a high-pressure hydraulic leak. Use a piece of wood or cardboard as a backstop instead of hands to isolate and identify a leak.
6. If injured by a concentrated high pressure stream of hydraulic fluid, seek medical attention immediately. Serious infection or toxic reaction can develop from hydraulic fluid piercing the skin's surface.
7. Before applying pressure to the system, make sure all components are tight and that lines, hoses, and couplings are not damaged.
8. On self-contained hydraulic systems, make sure that shut off valves are in open position before engaging PTO.

## **2.5 Transport Safety**

1. Read and understand all information in the Operator's Manual regarding procedures and safety when operating the machine in the field or on the road.
2. Make sure the Slow Moving Vehicle (SMV) emblem and required lights and reflectors are in place, clean, and can be seen clearly by all overtaking and oncoming traffic.
3. Do not allow riders on any part of the machine during either field operation or travel.
4. Attach the machine to the tractor using only a drawbar pin with provisions for a mechanical retainer.
5. Always attach a safety chain.
6. Always use hazard warning flashers when transporting unless prohibited by law.
7. Always move all parts of the machine to transport position when travelling on a road.
8. Stay away from overhead obstructions, such as power lines.
9. For max transport speed on smooth roads, see section 3.3.

## 2.6 Safety Decals

The types of decals on the equipment are shown in the illustration below. Proper safety requires that you familiarize yourself with the various safety decals, the type of warning, and the area, or particular function related to that area, that requires your safety awareness.

**REMEMBER:** If safety decals have been damaged or removed, become illegible, or parts are replaced without decals, then new decals must be applied. New decals are available from your authorized dealer.

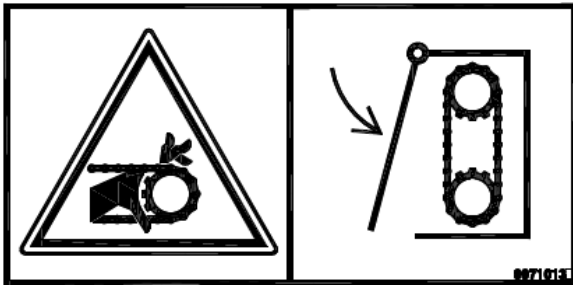

PN: 9971013

**Hazard:** Moving Parts

**Avoidance:** Keep shields and doors in place at all times when operating the machine.

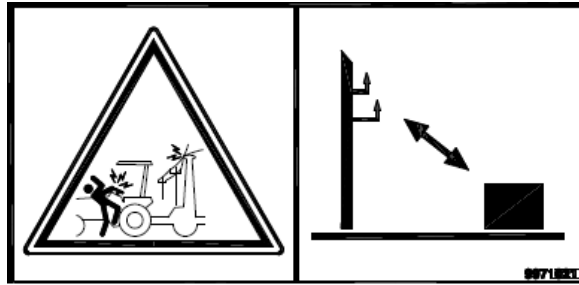

PN: 9971021

**Hazard:** Electrical Shock

**Avoidance:** Stay clear of overhead power lines and other obstructions.



PN: 303265

**Hazard:** Crushing from Above

**Avoidance:** Never crawl or work under machine unless it is properly supported.

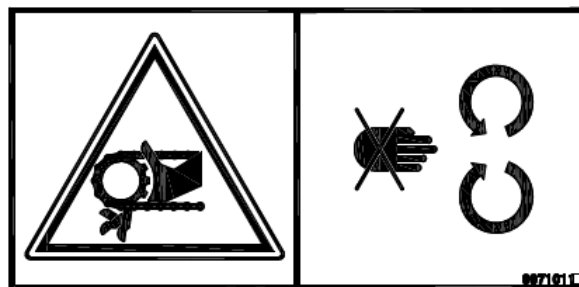

PN: 9971011

**Hazard:** Moving Parts

**Avoidance:** Keep hands, feet, hair, and clothing away from moving parts.

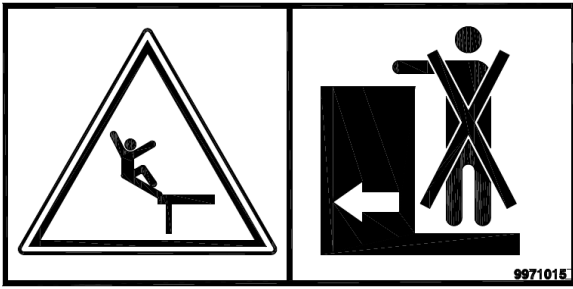

PN: 9971015

**Hazard:** Falling off Machine

**Avoidance:** Do not climb on the machine.

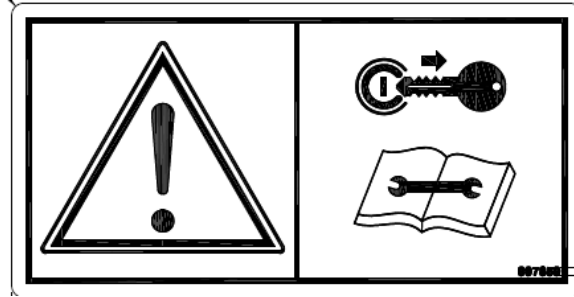

PN: 997859

**Hazard:** General Safety Alert

**Avoidance:** Shut off engine and remove key before performing maintenance or repair work.



PN: 303277

**Hazard:** Falling off Machine

**Avoidance:** Do not climb on the machine.

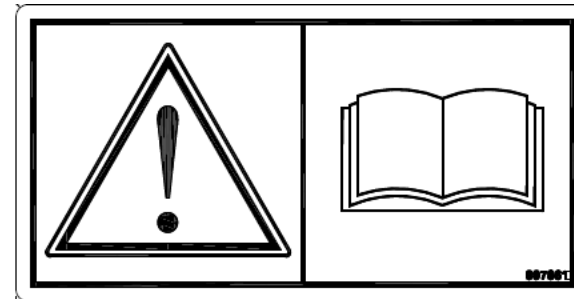

PN: 997861

**Hazard:** General Safety Alert

**Avoidance:** Read and understand the Operator's Manual before operating the machine.

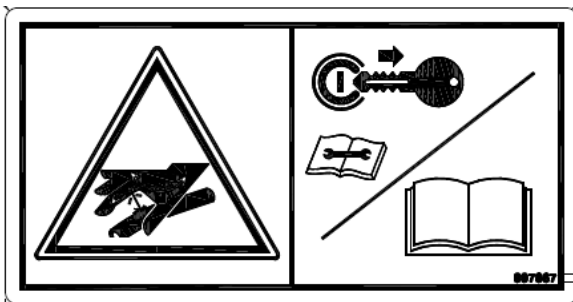

PN: 997867

**Hazard:** High Pressure Fluid

**Avoidance:** Relieve pressure on system before repairing, adjusting, or disconnecting. Wear proper hand and eye protection when searching for leaks. Use wood or cardboard instead of hands. Keep all components in good repair.



PN: 303263

**Hazard:** Getting Limbs or Clothing Stuck in Machine

**Avoidance:** Keep hands, feet, hair, and clothing away from moving parts.

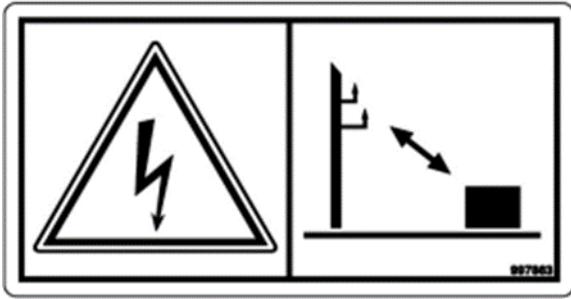

PN: 997863

**Hazard:** Electrical Shock

**Avoidance:** Keep the machine clear of overhead electrical power lines.



PN: 303268

**Hazard:** Rotating Part

**Avoidance:** Keep clothing, yourself, and others clear.

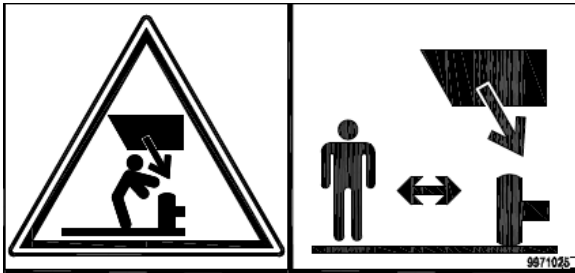

PN: 9971025

**Hazard:** Crushing from Above

**Avoidance:** Stay clear of this area while engine and machine are operating.

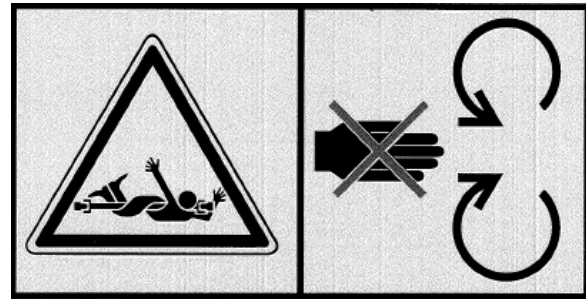

PN: 311206

**Hazard:** Whole Body Entanglement

**Avoidance:** Do not remove safety shield while engine is running.



PN: 307165

**Hazard:** Flying Debris

**Avoidance:** Keep top door closed when flails are rotating.



PN: 303267

**Hazard:** Rotating Flails

**Avoidance:** Do not approach machine until flail rotation has stopped.



PN: 311207

**Hazard:** Pinch Point

**Avoidance:** Keep hands clear of any moving parts around the pinch point.

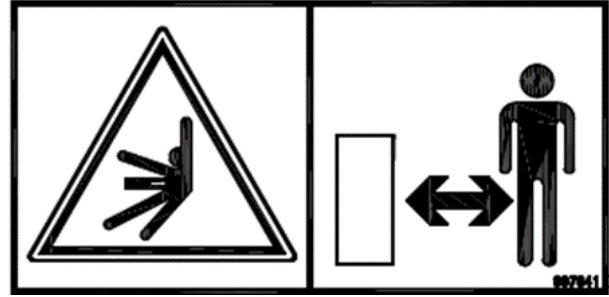

PN: 997841

**Hazard:** Crushing from Moving Parts

**Avoidance:** Stay clear of this area while engine and machine are operating.

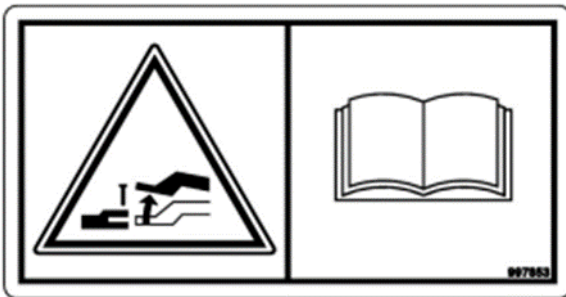

PN: 997853

**Hazard:** Negative Tongue Weight

**Avoidance:** Stay clear of the tongue when disconnecting the implement from the tractor. Read the Operator's Manual or safety information and operating instructions before operating the machine.



PN: 997857

**Hazard:** Loss of Machine Control

**Avoidance:** Install the safety chains when attaching the implement to the tractor. Read the Operator's Manual for safety information and operating instructions before operating the machine.

## 3.0 SPECIFICATIONS

### 3.1 Cart Specifications

Table 3-1: Cart Specifications

<b>Weight (Approx.)</b>	52,200 lbs [23,678 kg]
<b>Tank Capacity</b>	Top Pin Location: 65,000 lbs [29,484 kg] Middle Pin Location: 72,000 lbs [32,659 kg] Bottom Pin Location: 80,000 lbs [36,288 kg] (See section 4.6 for pin location information)
<b>Max Road Speed Travel</b>	20 mph [32.2 kph]
<b>Operating Speed (Loaded)</b>	10 mph [16.1 kph]
<b>Transport Height</b>	13.5 ft [4.11 m]
<b>Field Position Height</b>	13.5 ft [4.11 m]
<b>Transport Width</b>	14 ft [4.27 m]
<b>Field Position Width</b>	14 ft [4.27 m]
<b>Overall Machine Length</b>	35.4 ft [10.79 m]

Table 3-2 shows a list of tested and approved products that can be unloaded from the Crop Chaser 1000. If using the cart for a product that is not on this list, please contact your local Amity dealer before doing so.

Table 3-2: Approved Product Specifications

Approved Products
Sugarbeets
Dry Beans
Soybeans
Corn
Silage

### 3.2 Track Specifications

Table 3-3: Track Size

<b>Width</b>	3 ft [0.91 m]
<b>Length</b>	11.35 ft [3.46 m]
<b>Height</b>	3.4 ft [1.04 m]
<b>Width Center to Center</b>	8.4 ft [2.56 m]
<b>Maximum Transport Duration</b>	2 hours of continuous service

### 3.3 Tractor Specifications

Table 3-4: Tractor Specifications

<b>Minimum Weight</b>	34,800 lbs [15,785 kg]
<b>Hitch Category</b>	4/5
<b>Minimum Hydraulic Capacity</b>	42 GPM [159 L/m]
<b>Hydraulic Pressure</b>	2700 psi [18.6 Mpa]
<b>Number of SCVs</b>	6
<b>Case Drain</b>	Required

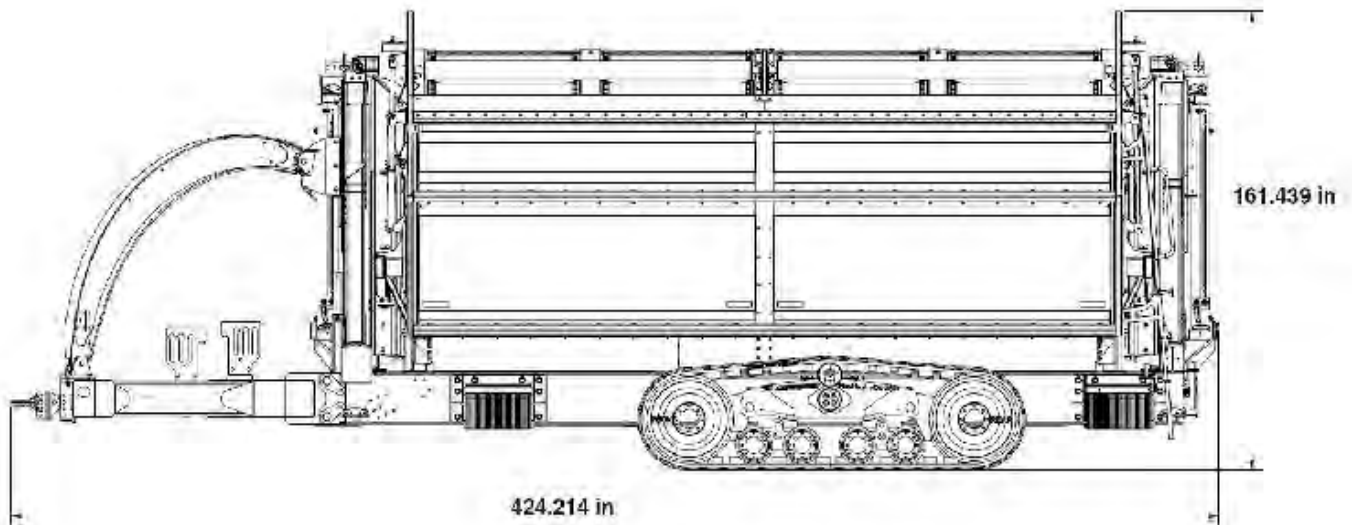
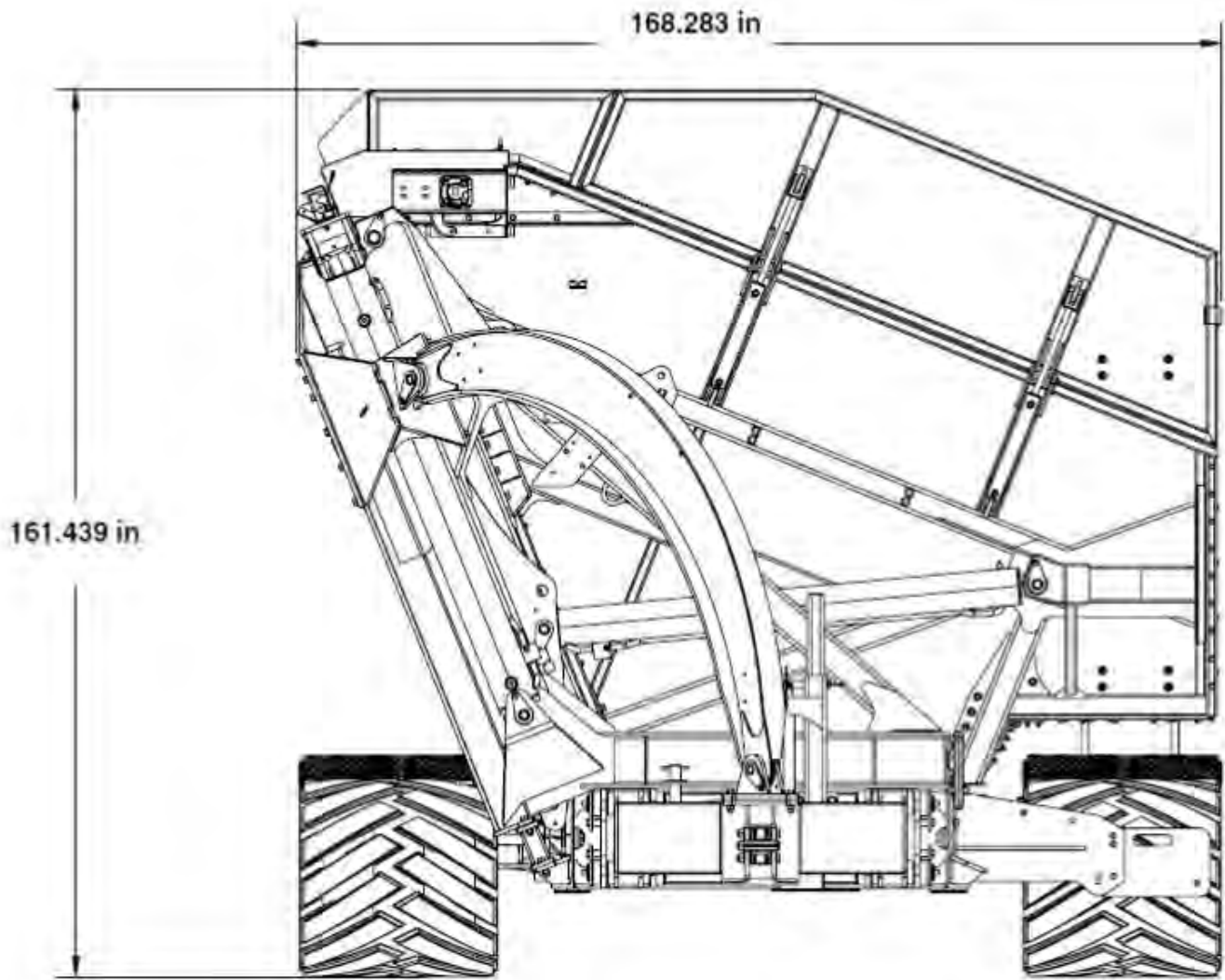



## **4.0 PREPARATION**

### **4.1 Tractor Safety Preparation**

1. Be sure the tractor is capable of safely towing and operating the cart.
2. Be sure the cart has been serviced according to the maintenance procedures in the manual.
3. Check the condition of the track.
4. Be sure all safety decals are in place and undamaged.
5. The weight monitor must be securely mounted in the cab of the tractor.
6. If equipped, check the cameras for clarity, position and operation.

### **4.2 Installing Hitch**

1. The cart is equipped with a Category 3-4 implement hitch. A Category 5 hitch (1) is mounted on the top of the hitch and can be installed if necessary.

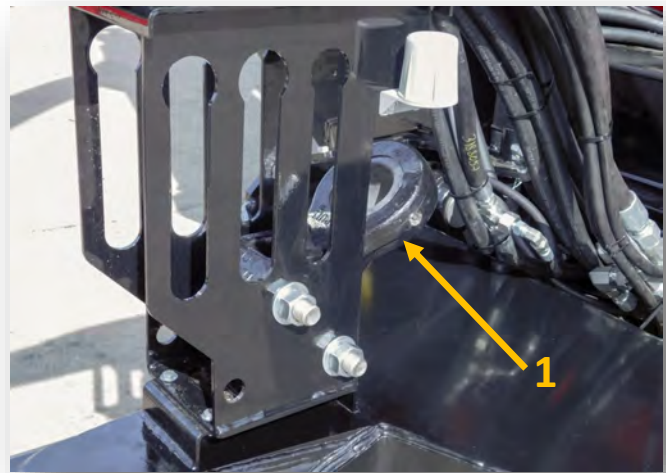

Figure 4-1: Category 5 Hitch

2. To install the Category 5 hitch, remove the three bolts and locknuts (1) from the Category 4 hitch. Remove the hitch.

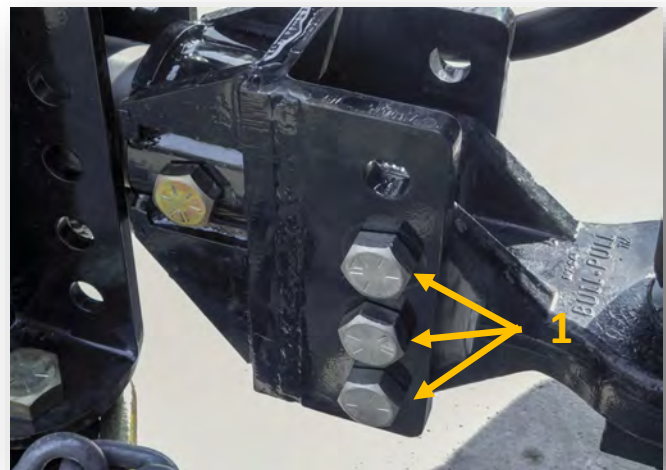

Figure 4-2: Hitch Removal

3. Remove the bolts (1) and nuts (2) from the Category 5 hitch. Use the bolts and nuts removed in Step 8 to install the Category 5 hitch. Tighten the bolts to 970 - 1090 ft-lb (1315 - 1480 N•m). Install the Category 4 hitch in the storage spot and secure with the bolts (2) and nuts (1).

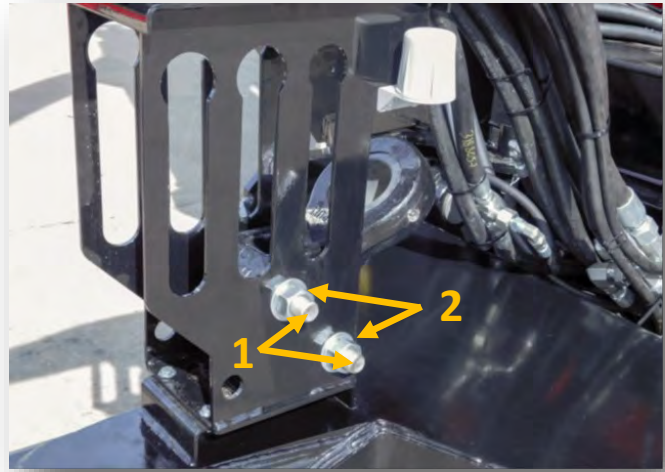

Figure 4-3: Category 5 Hitch Installation

### 4.3 Installing Front and Rear Weights

The cart is equipped with a front (1) and rear (2) weight rack that can hold up to 1100 lbs (499 kg) each.

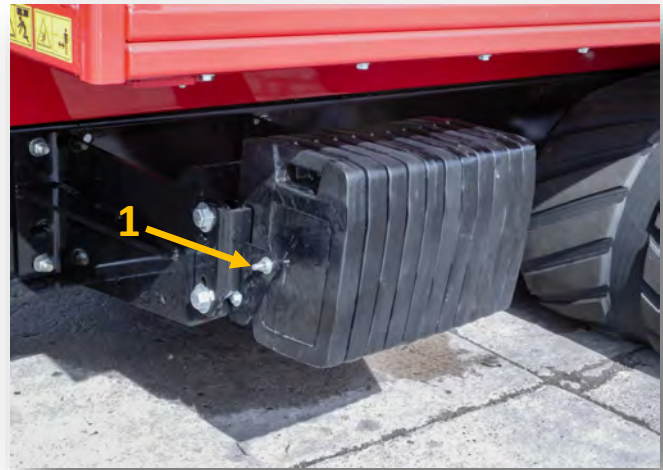

Figure 4-4: Front Weight Rack



Figure 4-5: Rear Weight Rack

#### 4.4 Check Unloading Chains

Be sure there is no more than 1-1.5 inches of deflection in the unloading chains and that each chain has the same deflection.



Figure 4-6: Unloading Chain

#### 4.5 Check Drive Motor Chains

Visually inspect drive motor chains (1) for tension and wear.



Figure 4-7: Drive Motor Chain

#### 4.6 Tilt Cylinder Pin Location

There are three locations for the bottom pin of the front and rear tilt cylinders. Moving the pin will adjust how far the tank tilts. The pin location is a limiting factor for tank capacity. Refer to the following table and corresponding image for maximum tank capacity.

Pin Location	Max Tank Capacity
1	65,000 lbs [29,484 kg]
2	72,000 lbs [32,659 kg]
3	80,000 lbs [36,288 kg]

Table 4-1: Tank Capacity Chart

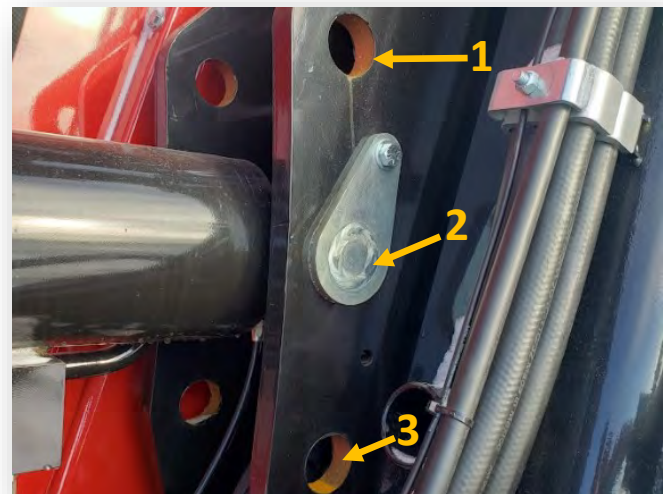

Figure 4-8: Tilt Cylinder Pin Location

## 5.0 ATTACHING AND DETACHING

**WARNING:** Never allow anyone between the tractor and implement when connecting or disconnecting the implement until the implement is completely supported on the tow bar, the engine is stopped and the park brake is applied.

### 5.1 Attaching Hydraulic and Electrical Systems

1. With the cart sitting on the hydraulic jack stand, back the tractor in front of the hitch.



Figure 5-1: Hydraulic Jack in Lowered Position

2. Connect the hydraulic hoses from the machine to the tractor. Be sure the hose couplers are secured in the tractor's couplers.

CC1000 HOSE CHART	
Green	Lift Cylinders
Orange	Tilt Cylinders
Red	Front Floor Chain
Blue	Rear Floor Chain
Black	Hydraulic Jack
Yellow	Flip Down Tank Door
None	Case Drain

PN: 319013

Table 5-1: Hydraulic Hose Chart



Figure 5-2: Attaching Hydraulic Hoses

3. Install the safety light connector (1) to the tractor.

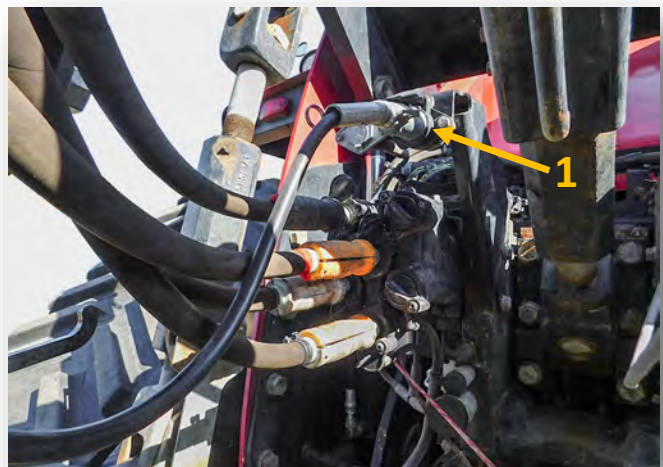

Figure 5-3: Attaching Safety Light Connector

## 5.2 Attaching Cart to Tractor Drawbar

1. Adjust the height of the hitch (1) using the hydraulic controls in the tractor. Be sure to line the hitch up in the center of the drawbar (2).

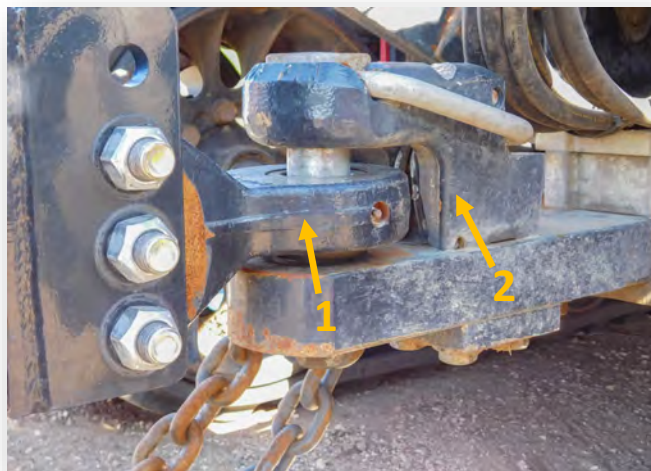

Figure 5-4: Hitch Height

2. With the hitch and draw bar properly aligned, install the pin (1).



Figure 5-5: Hitch Pin

- ! IMPORTANT:** Be sure the pin mechanical lock device is in place. The device may be a pin lock loop (1) as shown or a cross pin at the bottom of the drop pin.

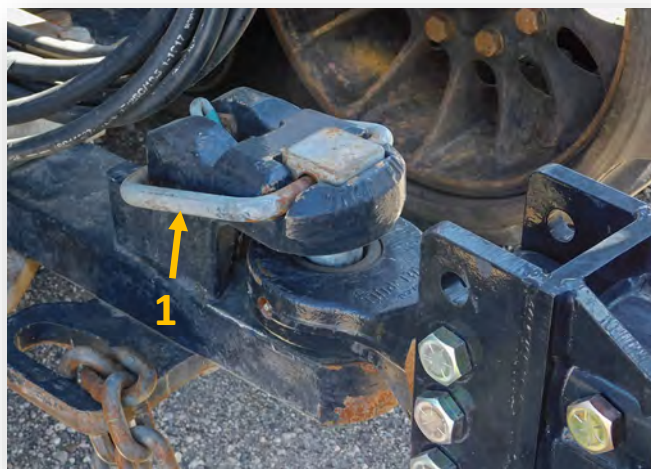

Figure 5-6: Hitch Pin Lock Loop

3. Install the safety chain (1) as shown.



Figure 5-7: Safety Chain

**! IMPORTANT:** Be sure the safety chain lock (1) is secured.

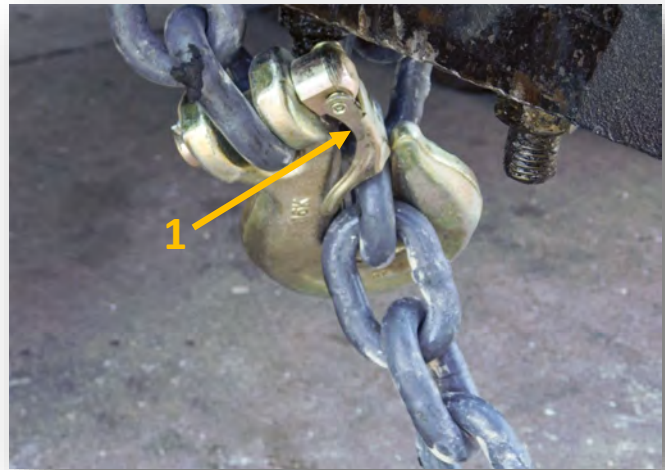

Figure 5-8: Safety Chain lock

4. Raise the hydraulic jack (1) before moving cart. Insert pin (2) to keep jack in place.



Figure 5-9: Hydraulic Jack in Raised Position.

### 5.3 Testing for Proper Operation

1. Start the tractor and check that all the hydraulic operations are correct.
2. Raise and lower the tank completely.
3. Tilt the tank completely and return to the stored position.



Figure 5-10: Cart with Tank in Lowered Position

## 6.0 OPERATING THE CART

### 6.1 Startup

After entering the field for the first time of each season, completely cycle the tank lift and tilt controls to purge any air in the system. When operating, hold the controls 3 to 5 seconds past movement.

**!** **WARNING:** When lifting tanks beware of overhead utility lines.

### 6.2 Filling The Cart

1. Carefully position the cart under the loading device (auger, elevator or conveyor). Be sure the cart does not contact any part of the harvesting or loading equipment.
2. Follow the directions of the harvesting or loading equipment operator for positioning the cart during loading.
3. The front top gate (1) can be lowered to allow better clearance and visibility.



Figure 6-1: Front Top Gate in Lowered Position

**!** **CAUTION:** A clear line of sight or communication must be maintained between the operator of the loading equipment and the operator of the cart.

4. **The operator must watch the weight monitors to prevent overloading. The maximum capacity of the cart is 80,000 lbs.**
5. If loading while in motion, the cart speed must match the harvesting equipment speed up to a maximum of 10 mph (17 km/h).
6. The cart must be loaded as evenly as possible to have better control during the unloading process. **Do not overload the cart.**

**!** **CAUTION:** Do not elevate the tank during loaded travel. This would change the center of gravity of the cart and cause handling or tipping problems on turns or side inclines.

**NOTE:** The turning radius of the cart and tractor depends on the capabilities of the tractor and the distance between the hitch and the centerline of the cart tracks.



### 6.3 Unloading the Cart

**! WARNING:** Be sure that there are no bystanders near the cart before starting to unload and that no one approaches the cart during the unloading process.

**! CAUTION:** Always position the cart on level ground when unloading.

1. Position the cart parallel to the receiving unit (a truck, for example). The distance between the lip (1) of the cart and the top edge (2) of the receiving unit should be 24 to 36 inches (60 - 90 cm).

**NOTE:** The distance is determined by the height of the receiving unit. If the unit is lower than the cart the distance could be 24 inches (60 cm). If the receiving unit is taller than the cart, the cart tank will move 8 inches (30) cm closer for every 24 inches (60) cm the tank is raised.

The distance between the cart and the unit to be loaded may vary with the type of product being unloaded from the cart. The first time the cart is unloaded, be very careful to see how the product pours from the cart into the receiving unit. This will provide a reference for the distance between the cart and the receiving unit.

2. Position the cart front to back to be sure the contents of the tank will flow entirely into the receiving unit.
3. Raise the front of the tank until the lip (1) is about 36 inches (90 cm) above the receiving unit (2).



Figure 6-2: Tank Distance from Receiving Unit



Figure 6-3: Raising Tank

### 6.3 Unloading the Cart (Continued)

4. Slowly tilt the tank to empty into the receiving unit. Monitor the amount of distribution of the load in the receiving unit.

**NOTE:** It may be necessary to adjust the distance between the cart and the receiving unit or height of the tank when it is tilted. Lower the tank before moving the cart. Make note of any changes to position between the cart and receiving unit for the next unloading.

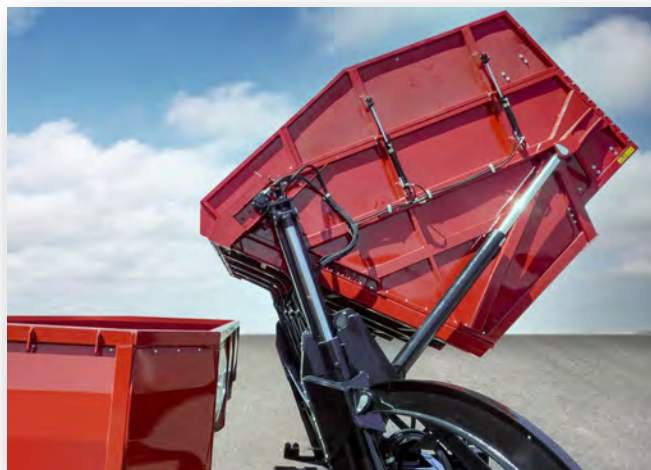

Figure 6-4: Tilting Tank

5. Use the unloading chains to better control the amount and distribution from the tank to the receiving unit. The chains can be used to initiate the unloading process before the tank is completely tilted. The unloading chains can also be used to dislodge any material left in the lower right corner of the tank. Speed of the chains can be changed by adjusting the hydraulic flow.
6. Return the tank to travel position.
7. Drive straight forward until the back of the tank is clear of the receiving unit including the tow vehicle before turning. The cart pivots on the tracks and the back of the cart swings out during turns.
8. After the final load of the day or shift, clean any excess product from the tank. If left, it can dry and harden which will cause excess buildup during the next use.

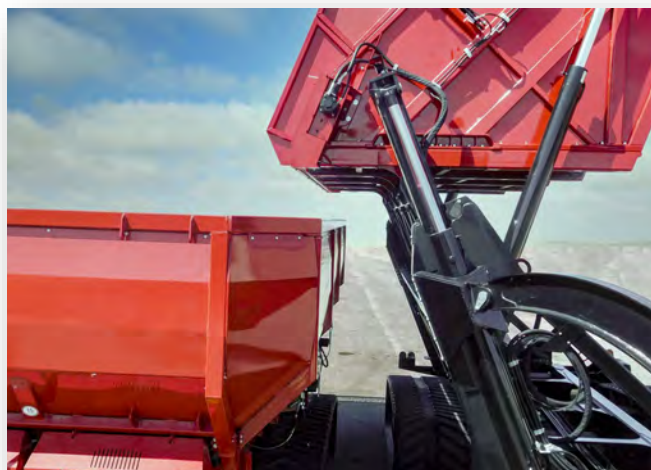

Figure 6-5: Use of Unloading Chains



Figure 6-6: Cart in Lowered Position

## 6.4 Scale System

The Amity Cart uses the Agrimatics Libra Cart scale system which is a tablet and smartphone-based weighing and data management system.

The Operator's Manual for the Libra Cart system is supplied with the Amity cart. The most current Operation Manual can be found online at:

[https://www.agrimatics.com/html\\_help/cart/index](https://www.agrimatics.com/html_help/cart/index)



Figure 6-4: Tilting Tank

## **7.0 TRANSPORTATION**

### **7.1 Warning Lights**

**!** **CAUTION:** Prevent collisions between other road users, slow moving tractors with attachments or towed equipment and self-propelled machines on public roads. Frequently check for traffic from the rear, especially in turns. Use turn signal lights on every turn.

Use headlights, flashing warning lights and turn signals day or night. Follow all local and state regulations for equipment lighting and marking. Keep lighting and marking visible and in good working order. Repair or replace lighting or marking that has been damaged or missing.



Figure 7-1: Transporting Cart

### **7.2 Preparing For Transport**

1. Be sure all hydraulics are connected and operating correctly.
2. Be sure the hitch pin is in place and secured.
3. Be sure the safety chains are connected correctly.
4. Be sure the implement jack is completely retracted.
5. Clean all soil and debris from the cart.
6. Inspect all safety decals and lights are clean, visible and operational.
7. The transportation position for the cart is with the tank completely lowered on the frame.
8. Be sure the rear-facing camera is operational and clean.

**!** **CAUTION:** Breaking distance is greatly increased when towing the cart.

**NOTE:** Maximum speed during transportation is 15 mph (25 km/h).

**!** **WARNING:** Be aware of overhead obstructions or low power lines.

## 7.2 Preparing For Transport (continued)

**NOTE:** The turning radius of the cart and tractor depends on the capabilities of the tractor and the distance between the hitch and centerline of the cart tracks. A minimum turning radius of three times the distance of the total length of the tractor and cart.

It is recommended that the operator does some practice turns with the empty cart to see what the turning capabilities are for the tractor cart combination before using the cart.

 **CAUTION:** The cart must not come into contact with the tractor during a turn.

 **CAUTION:** Do not elevate the tank during transport. This would change the center of gravity of the cart and cause handling or tipping problems on turns or side inclines.

## 8.0 MAINTENANCE

### 8.1 Cleaning

Cleaning is an important part of cart maintenance. The entire cart should be annually cleaned at the end of the season to remove dirt and debris which can attract moisture and cause rust to form. Some specific areas are more prone to dirt and debris buildup.

Any level surface like the tops of the frame rails (1), the track undercarriage (2), the top surface of bracing (3) and anywhere bracing components meet (4) to form a cradle for dirt and debris.



Figure 8-1: Areas of Debris Buildup

The tank can be raised to clean the top of the frame or access the tank drain plugs. Perform the following steps to place tank safety pin in lock position.

 **WARNING:** Do not stand beneath tank before placing tank safety pins into lock position.



Figure 8-2: Tank Raised for Cleaning

Before performing any cleaning with the tank raised, remove the stop pins from the front and rear storage holders.



Figure 8-3: Tank Safety Pin Storage Location

Install the pin in the safety lock position.



Figure 8-4: Tanks Safety Pin Lock Position

The cart has four drain plugs (1) under the tank. Remove the drain plugs (1) to empty the water or fluid from the tanks.



Figure 8-5: Drain Plug

## 8.2 Lubrication

Lubricate the cart according to the following schedule.

**IMPORTANT:** The following time schedule is for cart use in normal conditions. Severe or unusual conditions may require more frequent lubrication.

### ***Grease Type***

Use only SAE multipurpose high temperature/extreme pressure grease with less than 1% molybdenum disulfide.

**IMPORTANT:** Clean all Grease fittings before lubricating. Replace any missing or damaged fittings immediately. If a fitting fails to take grease, replace it.

### ***Before 1st Use***

1. Grease the hitch and check all other grease points
2. Grease upper and lower lift cylinders
3. Grease both ends of all cylinders
4. Grease the top tilt rollers

### ***12 Hours\****

1. Grease upper and lower lift rollers.

### ***48 Hours\****

1. Grease both ends of all cylinders.
2. Lubricate the track assembly with a silicon base penetrating spray.
3. Grease the hitch implement ring.
4. Grease hitch pivot points.

### ***250 Hours\* or Annually***

1. Remove and clean upper and lower rollers. Inspect rollers for flat spots.
2. Remove and clean all cylinder pins. Check pins for any excessive wear or damage.
3. Remove and clean all hinge pins. Check pins for any excessive wear or damage.
4. Check the wear on the plastic lift slides. Replace if necessary.
5. Check the wear on all cylinder bushings. Replace if necessary.



### 8.3 Lubrication Locations

1. Rear tilt cylinder rod end (1).

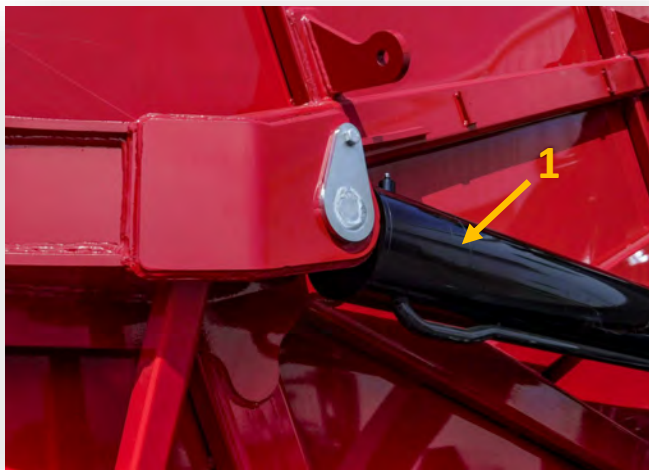

Figure 8-6: Rear Tilt Cylinder Rod End



Figure 8-7: Rear Tilt Cylinder Rod End Grease Fitting

### 8.3 Lubrication Locations (continued)

2. Rear lift cylinder base end (1).



Figure 8-8: Rear Lift Cylinder Base End



Figure 8-9: Rear Lift Cylinder Base End Fitting

### 8.3 Lubrication Locations (continued)

3. Rear base end of tilt (1) and rod end of lift (2) cylinders.

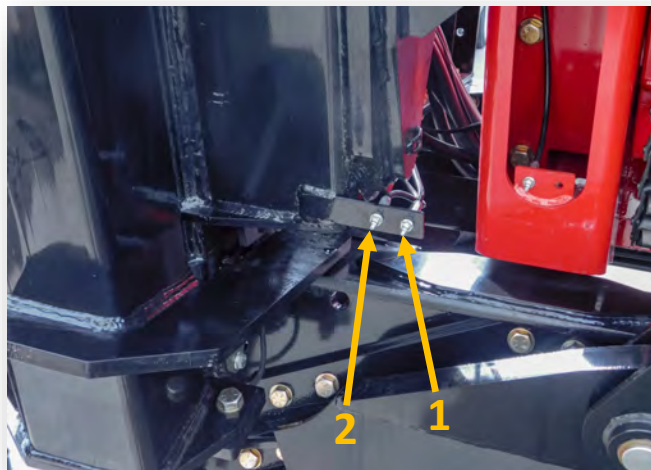

Figure 8-10: Grease Location

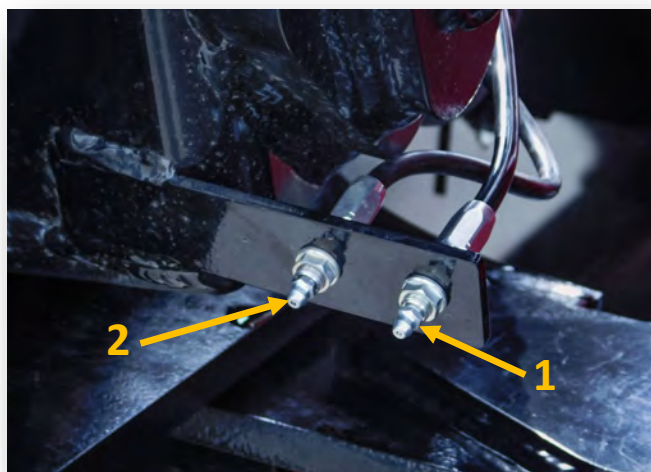

Figure 8-11: Grease Fittings

### 8.3 Lubrication Locations (continued)

4. Front lift cylinder base end (1).



Figure 8-12: Front Lift Cylinder Base End



Figure 8-13: Front Lift Cylinder Base End Grease Fitting

### 8.3 Lubrication Locations (continued)

5. Front tilt cylinder rod end (1).



Figure 8-14: Front Tilt Cylinder Rod End

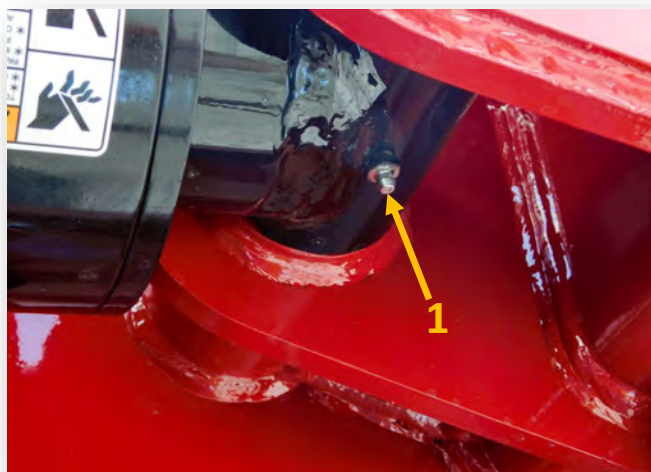

Figure 8-15: Front Tilt Cylinder Rod End Grease Fitting

### 8.3 Lubrication Locations (continued)

6. Front base end of tilt (1) and rod end of lift (2) cylinders.

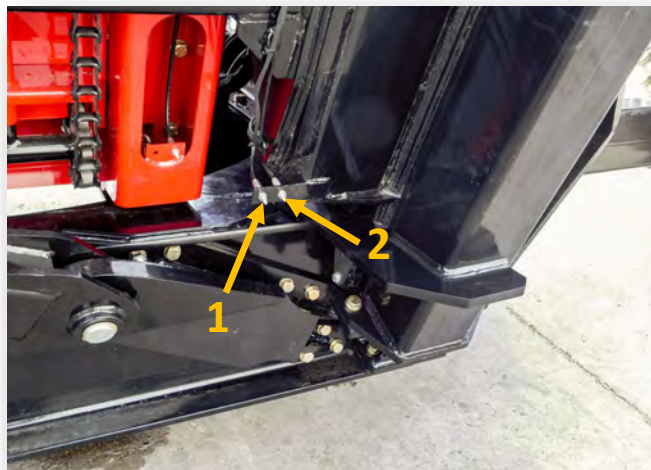

Figure 8-16: Grease Location

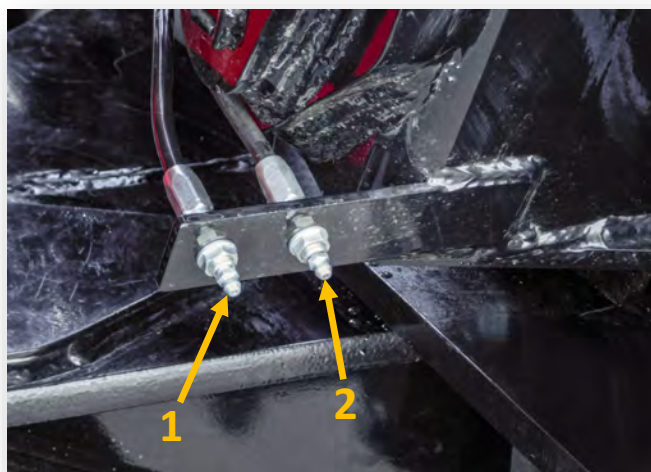

Figure 8-17: Grease Fittings

### 8.3 Lubrication Locations (continued)

7. Base end (1) of jack cylinder.

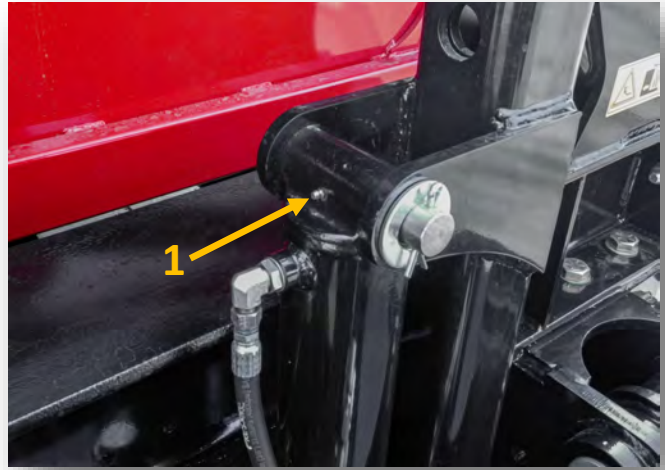

Figure 8-18: Base End of Jack Cylinder

8. Rod end (1) of jack cylinder.



Figure 8-18: Rod End of Jack Cylinder

9. Rear head shaft bearings (1).

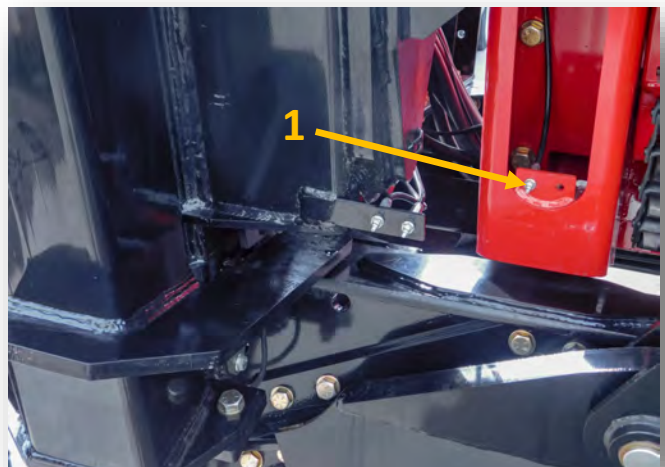

Figure 8-19: Rear Head Shaft Bearings

### 8.3 Lubrication Locations (continued)

10. Middle head shaft bearings (1). Two locations.

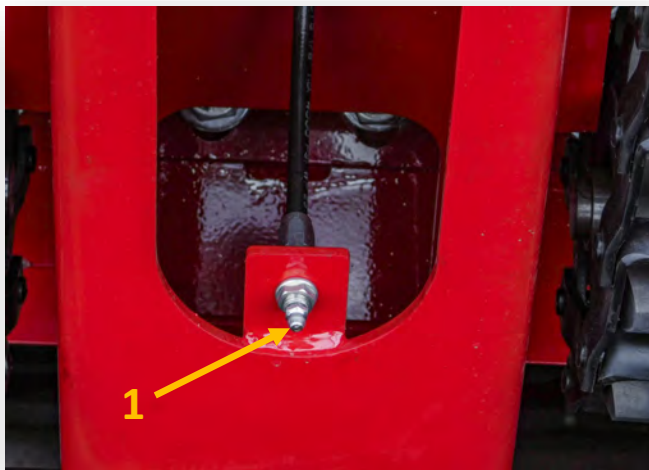

Figure 8-20: Grease Location

11. Inside ends of head shaft bearings (1).



Figure 8-21: Grease Location

12. Front head shaft bearing (1).

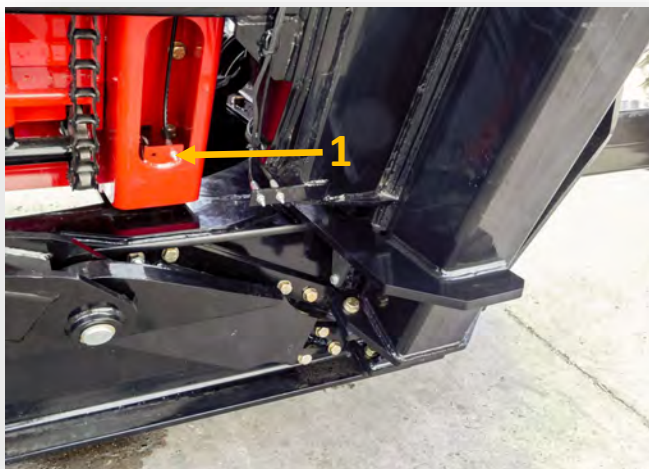

Figure 8-22: Grease Location



### 8.3 Lubrication Locations (continued)

13. Hitch implement ring (1).

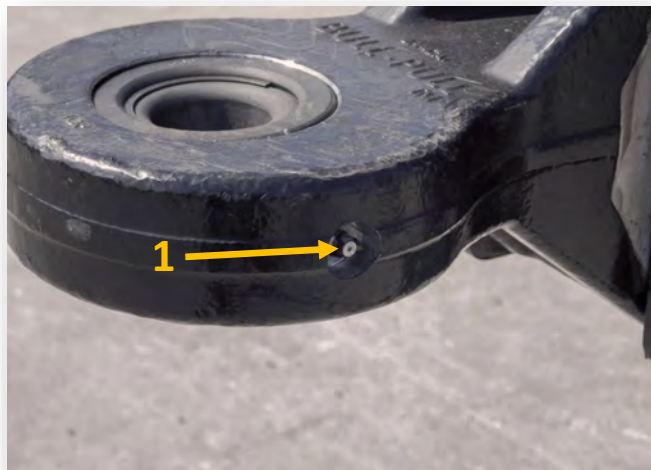

Figure 8-23: Hitch Implement Ring

### 8.4 Track Undercarriage Lubrication

1. The grease points and frequency for the track undercarriage is on the placard (1) attached to the frame.
2. See the Track Operator's Manual (provided with the cart) for changing the oil in the idler and midroller hubs and changing the grease in the top roller wheel hubs

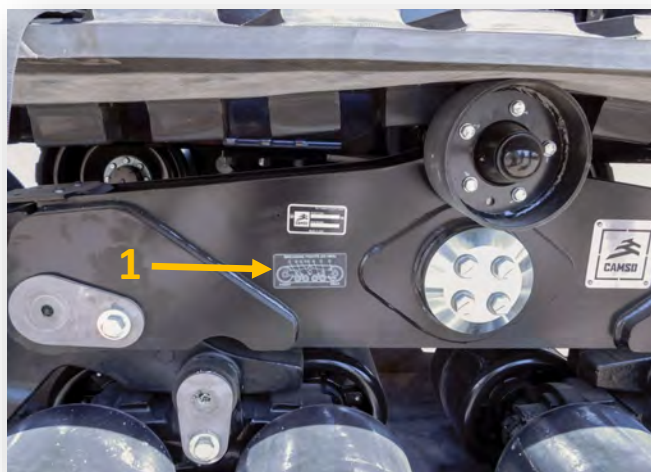

Figure 8-24: Grease Information Placard

## 8.5 Chain Tensioning

1. The unloading chain must have a minimum of 1-1/2 inches of deflection (1).
2. To adjust the unloading chain tension, loosen the lock nut (2) and turn the adjusting screw position (3) then tighten the lock nut (2).
3. Repeat steps 1 and 2 for all the adjusting screws.



Figure 8-25: Unloading Chain Tension

**IMPORTANT:** Each chain must be equally tensioned on both sides or they will not work properly and could cause damage to the machine.



Figure 8-26: Unloading Chain Tension Adjusting Screw

4. To adjust the tension on the unloading chain drive motor chain, rotate the adjusting nut (4) clockwise to increase and counterclockwise to decrease the tension.



Figure 8-27: Drive Motor Chain Tension

## **9.0 STORAGE**

### **9.1 End of The Season**

1. Thoroughly clean the cart inside and out. Debris and dirt will draw and hold moisture and cause rust.
2. Inspect the cart for any damaged or worn components, repair or replace as required.
3. Paint any surfaces that have exposed bare metal to prevent rusting.
4. Inspect all hydraulic hoses and components for leaks and repair immediately.
5. Move the cart to a level, dry and clean area.
6. Remove all eight tank drain plugs and store with the cart.
7. Put blocking material under the hitch or lower the hitch so the cart is supported by the hitch jack and blocking material.

### **9.2 Beginning of The Season**

1. Review the Operator's Manual before field operations.
2. Check the cart for any loose or damaged components. Tighten any components including guards and shields.
3. Install the eight drain plugs.

**IMPORTANT:** All components that are damaged or worn must be repaired or replaced before operating the cart. See the Parts Book for part numbers.

4. Attach the cart to the tractor hydraulics.
5. Lower the hitch jack until the blocking can be removed.
6. Connect the cart to the tractor hitch.
7. Stop the engine and place the tractor in PARK.
8. Lubricate the entire cart to force out any moisture that accumulated while in storage.
9. Run the cart to ensure proper function.